

KAMERTON S Louver

Art. Nr. 5.3201.04D1.C77W.D0

LED | 4000 K | >90 | SDCM ≤3 | 50.000 h L80 B10 | IP20 | Casambi | 220-240V 50-60Hz |  | 



TECHNISCHE DATEN

Leuchtenleistung: **37,6 W CC HO (High output)**
Bemessungslichtstrom: **5100 lm**
Farbtemperatur: **4000 K**
Farbwiedergabe: **>90**
Farbtoleranz [SDCM]: **≤3**
Mittlere Lebensdauer: **50.000 h, L80 B10**
Diffusor / Optik: **Wide beam (UGR<19)**

Montageart, Lichtverteilung: **Abgependelt, direkt (SD)**
Energieversorgung: **220-240V, 50-60Hz**
Steuerung: **Casambi**
Schutzklasse: **I**
Schutzart: **IP20**
Leuchtenkörper: **Extruded aluminium profile**
Leuchtenfarbe: **powder coated: sandy**

TECHNISCHE ZEICHNUNG

Maße: **2197x44 mm**

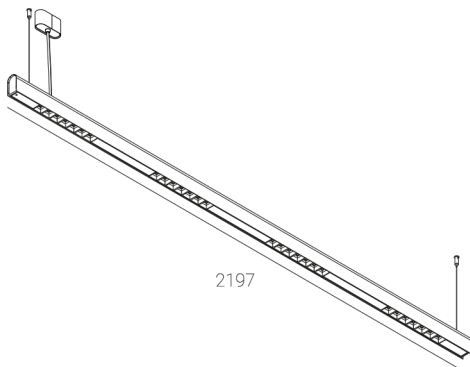

PHOTOMETRISCHE DATEN

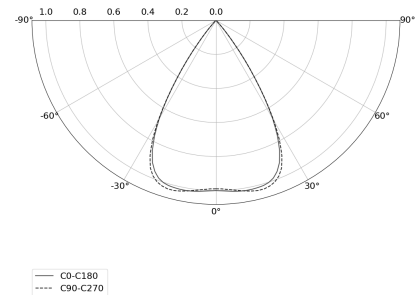

ZUBEHÖR (SEPARAT ZU BESTELLEN)

SONSTIGES