

KAMERTON S Louver

Art. Nr.: 5.3201.0411.C77W.50

LED | 4000 K | >90 | SDCM ≤3 | 50.000 h
L80 B10 | IP20 | Casambi | 220-240V
50-60Hz |  | 



TECHNISCHE DATEN

Leuchtenleistung: 37,6+23,5 W CC HO (High output)
Bemessungslichtstrom: 7886 lm
Farbtemperatur: 4000 K
Farbwiedergabe: >90
Farbtoleranz [SDCM]: ≤3
Mittlere Lebensdauer: 50.000 h, L80 B10
Diffusor / Optik: Wide beam (UGR<19)

Montageart, Lichtverteilung: Abgependelt, direkt/indirekt (SDI)
Energieversorgung: 220-240V, 50-60Hz
Steuerung: Casambi
Schutzklasse: I
Schutzart: IP20
Leuchtenkörper: Extruded aluminium profile
Leuchtenfarbe: powder coated: black (RAL9005)

TECHNISCHE ZEICHNUNG

Maße: 2197x44 mm

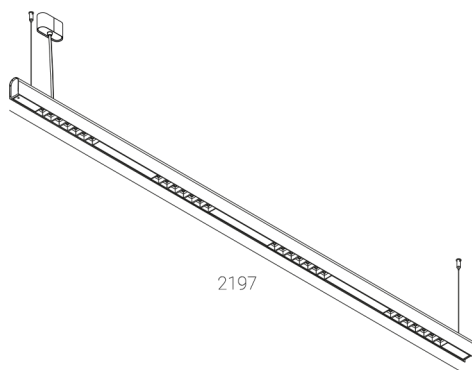

PHOTOMETRISCHE DATEN

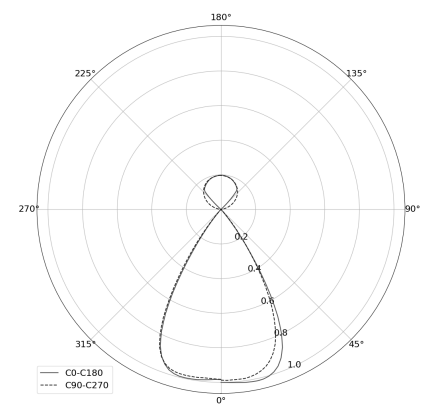

ZUBEHÖR (SEPARAT ZU BESTELLEN)

SONSTIGES