



KAMERTON S Louver

CODE: 5.3201.02D1.277W.H0

LED | 4000 K | >90 | SDCM ≤3 | 50.000 h L80 B10 | IP20 | DALI | 220-240V 50-60Hz |  |  |



TECHNICAL DATA

Power:	18,8 W CC HO (High output)	Mounting type:	Suspended, direct (SD)
Flux:	2550 lm	Power supply:	220-240V, 50-60Hz
CCT:	4000 K	Control:	DALI
CRI:	>90	Protection Class:	I
SDCM:	≤3	IP:	IP20
Durability of LED sources:	50.000 h, L80 B10	Material:	Extruded aluminium profile
Diffuser / Optic:	Wide beam (UGR<19)	Finishing:	powder coated: graphite (RAL7024)

TECHNICAL DRAWING

Dimensions: **1077x44 mm**

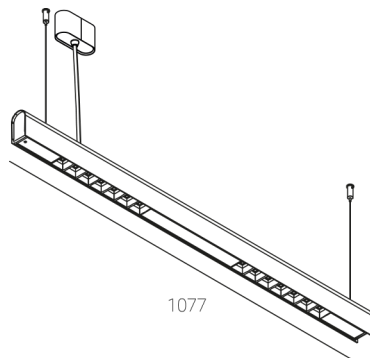

PHOTOMETRIC DATA

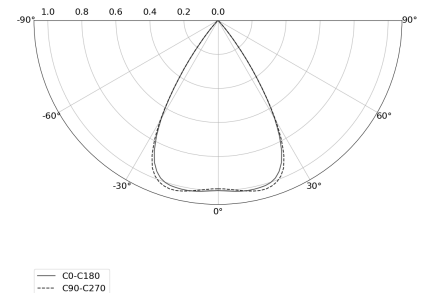

ACCESSORIES (ORDERED SEPARATELY)

OTHER