

KAMERTON S Louver

CODE: 5.3201.04D1.177W.V0

LED | 4000 K | >90 | SDCM ≤3 | 50.000 h
L80 B10 | IP20 | ON/OFF | 220-240V
50-60Hz |  |  |



TECHNICAL DATA

Power: 37,6 W CC HO (High output)
Flux: 5100 lm
CCT: 4000 K
CRI: >90
SDCM: ≤3
Durability of LED sources: 50.000 h, L80 B10
Diffuser / Optic: Wide beam (UGR<19)

Mounting type: Suspended, direct (SD)
Power supply: 220-240V, 50-60Hz
Control: ON/OFF
Protection Class: I
IP: IP20
Material: Extruded aluminium profile
Finishing: powder coated: volcano

TECHNICAL DRAWING

Dimensions: 2197x44 mm

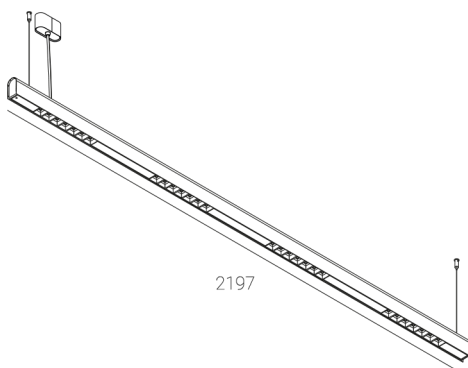

PHOTOMETRIC DATA

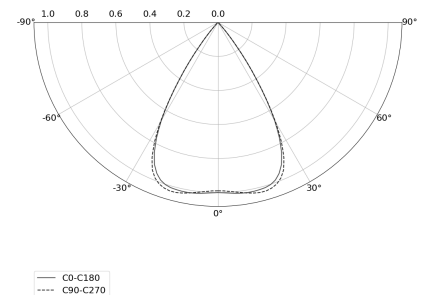

ACCESSORIES (ORDERED SEPARATELY)

OTHER