

KAMERTON S Louver

CODE 5.3201.0311.177W.40

LED | 4000 K | >90 | SDCM ≤3 | 50.000 h L80 B10 | IP20 | ON/OFF | 220-240V 50-60Hz |  | 

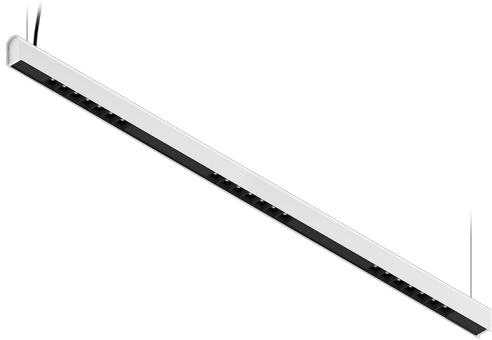

TECHNICAL DATA

Power: 28,2+16,8 W CC HO (High output)
Flux: 5815 lm
CCT: 4000 K
CRI: >90
SDCM: ≤3
Durability of LED sources: 50.000 h, L80 B10
Diffuser / Optic: Wide beam (UGR<19)

Mounting type: Suspended, direct/indirect (SDI)
Power supply: 220-240V, 50-60Hz
Control: ON/OFF
Protection Class: I
IP: IP20
Material: Extruded aluminium profile
Finishing: powder coated: white (RAL9016)

TECHNICAL DRAWING

Dimensions: 1637x44 mm

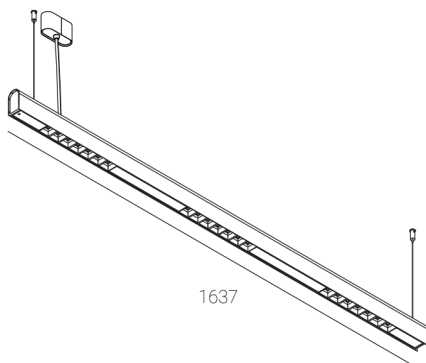

PHOTOMETRIC DATA



ACCESSORIES (ORDERED SEPARATELY)

OTHER