

KAMERTON S Louver

CODE: 5.3201.0311.267W.NO

LED | 3000 K | >90 | SDCM ≤3 | 50.000 h L80 B10 | IP20 | DALI | 220-240V 50-60Hz |  |  |

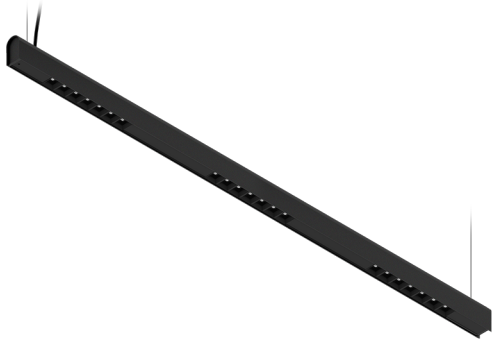

TECHNICAL DATA

Power: 28,2+16,8 W CC HO (High output)
Flux: 5436 lm
CCT: 3000 K
CRI: >90
SDCM: ≤3
Durability of LED sources: 50.000 h, L80 B10
Diffuser / Optic: Wide beam (UGR<19)

Mounting type: Suspended, direct/indirect (SDI)
Power supply: 220-240V, 50-60Hz
Control: DALI
Protection Class: I
IP: IP20
Material: Extruded aluminium profile
Finishing: powder coated: night

TECHNICAL DRAWING

Dimensions: 1637x44 mm

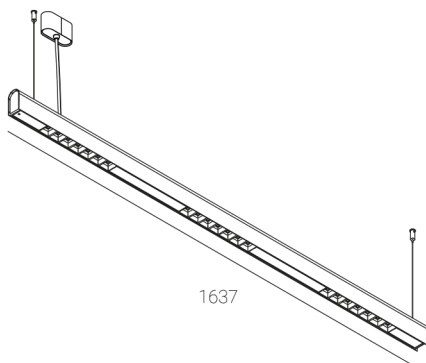

PHOTOMETRIC DATA



ACCESSORIES (ORDERED SEPARATELY)

OTHER