

## KAMERTON S Line

CODE: 5.3202.03D1.C77L.H0

LED | 4000 K | >90 | SDCM ≤3 | 50.000 h L80 B10 | IP20 | Casambi | 220-240V 50-60Hz |  |  |

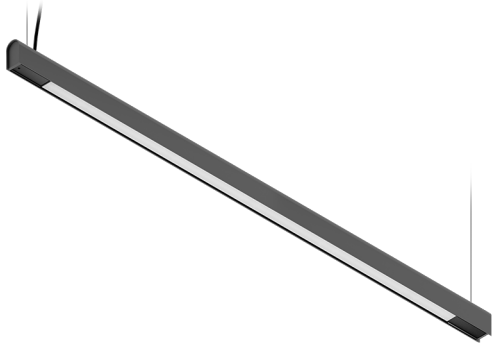

### TECHNICAL DATA

Power:	33,6 W CC HO (High output)	Mounting type:	Suspended, direct (SD)
Flux:	4475 lm	Power supply:	220-240V, 50-60Hz
CCT:	4000 K	Control:	Casambi
CRI:	>90	Protection Class:	I
SDCM:	≤3	IP:	IP20
Durability of LED sources:	50.000 h, L80 B10	Material:	Extruded aluminium profile
Diffuser / Optic:	Linear optic (satine)	Finishing:	powder coated: graphite (RAL7024)

### TECHNICAL DRAWING

Dimensions: 1637x44 mm

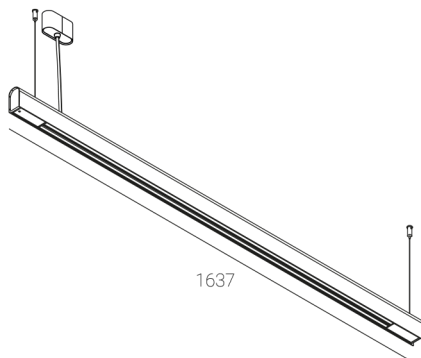

### PHOTOMETRIC DATA

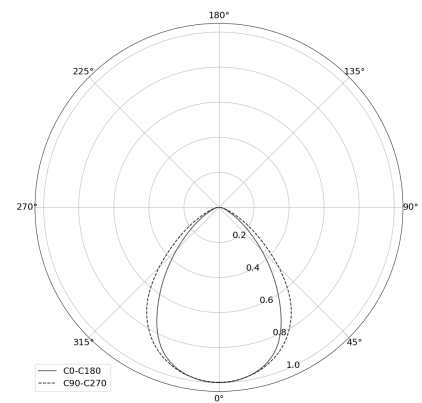

### ACCESSORIES (ORDERED SEPARATELY)

### OTHER