

KAMERTON S Line

CODE: 5.3202.0211.WA3L.NO

LED | 2700-3000K | >90 | SDCM ≤3 | 50.000 h
L80 B10 | IP20 | Dim to warm | 220-240V
50-60Hz |  |  |



TECHNICAL DATA

Power: 20,2+10,1 W CV HO (High output)
Flux: 3373 lm
CCT: 2700-3000K
CRI: >90
SDCM: ≤3
Durability of LED sources: 50.000 h, L80 B10
Diffuser / Optic: Linear optic (satine)

Mounting type: Suspended, direct/indirect (SDI)
Power supply: 220-240V, 50-60Hz
Control: Dim to warm
Protection Class: I
IP: IP20
Material: Extruded aluminium profile
Finishing: powder coated: night

TECHNICAL DRAWING

Dimensions: 1077x44 mm



PHOTOMETRIC DATA

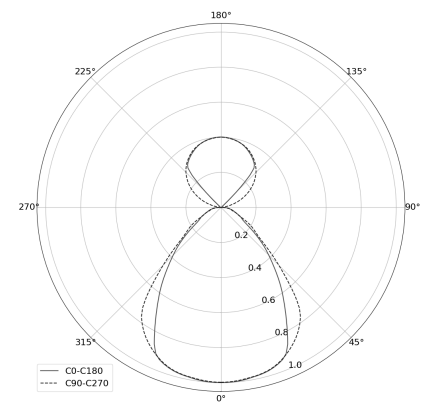

ACCESSORIES (ORDERED SEPARATELY)

OTHER