

KAMERTON S Line

CODE 5.3202.0411.277L.S0

LED | 4000 K | >90 | SDCM ≤3 | 50.000 h
L80 B10 | IP20 | DALI | 220-240V
50-60Hz |  |  |

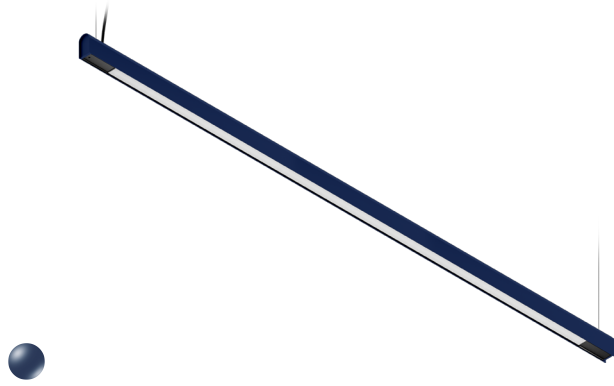

TECHNICAL DATA

Power: 47+23,5 W CC HO (High output)
Flux: 9051 lm
CCT: 4000 K
CRI: >90
SDCM: ≤3
Durability of LED sources: 50.000 h, L80 B10
Diffuser / Optic: Linear optic (satine)

Mounting type: Suspended, direct/indirect (SDI)
Power supply: 220-240V, 50-60Hz
Control: DALI
Protection Class: I
IP: IP20
Material: Extruded aluminium profile
Finishing: powder coated: saphire (RAL5003)

TECHNICAL DRAWING

Dimensions: 2197x44 mm



PHOTOMETRIC DATA



ACCESSORIES (ORDERED SEPARATELY)

OTHER