

## KAMERTON S Line

CODE: 5.3202.0411.C77L.W0

LED | 4000 K | >90 | SDCM ≤3 | 50.000 h L80 B10 | IP20 | Casambi | 220-240V 50-60Hz |  | 

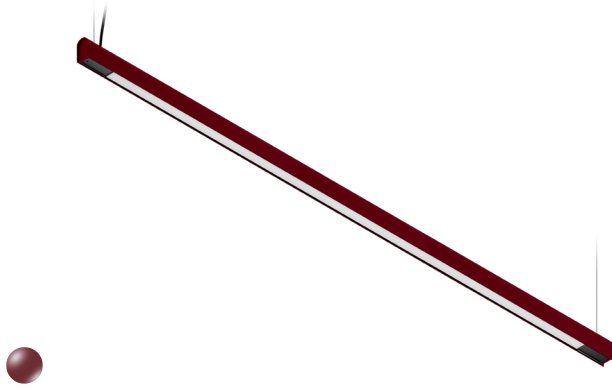

### TECHNICAL DATA

Power: 47+23,5 W CC HO (High output)  
Flux: 9051 lm  
CCT: 4000 K  
CRI: >90  
SDCM: ≤3  
Durability of LED sources: 50.000 h, L80 B10  
Diffuser / Optic: Linear optic (satine)

Mounting type: Suspended, direct/indirect (SDI)  
Power supply: 220-240V, 50-60Hz  
Control: Casambi  
Protection Class: I  
IP: IP20  
Material: Extruded aluminium profile  
Finishing: powder coated: wine (RAL3005)

### TECHNICAL DRAWING

Dimensions: 2197x44 mm



### PHOTOMETRIC DATA

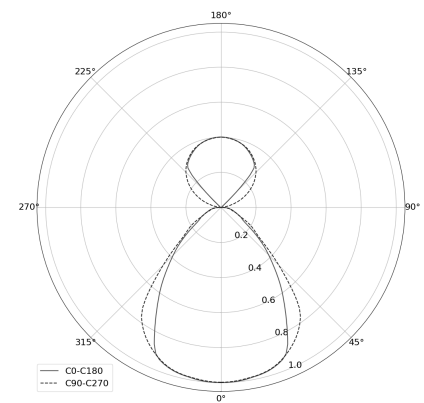

### ACCESSORIES (ORDERED SEPARATELY)

### OTHER